

CFD Analysis of an Automobile Catalytic Converter to Obtain Flow Uniformity and to Minimize Pressure Drop Across the Monolith

 Open
Access

 Soheli Khalil Shaikh¹, Khizar Ahmed Pathan², Zakir Ilahi Chaudhary³, Sher Afghan Khan^{4,*}
¹ Department of Mechanical Engineering, Hi-Tech Institute of Technology, Aurangabad, Maharashtra 431001, India

² Department of Mechanical Engineering, Trinity College of Engineering and Research, Pune, Maharashtra, 411048, India

³ Department of Automobile Engineering, M.H. Saboo Siddik College of Engineering, Mumbai, Maharashtra, 400008, India

⁴ Mechanical Engineering Dept., Faculty of Engineering, International Islamic University Malaysia, Kuala Lumpur, Selangor, 50728, Malaysia

ARTICLE INFO

ABSTRACT

Article history:

Received 23 July 2020

Received in revised form 21 September 2020

Accepted 24 September 2020

Available online 30 September 2020

The catalytic converter is a device which converts harmful exhaust gases from internal combustion engine into harmless gases. Global warming and air pollution are a buzz in today's scenario. Greenhouse gasses are responsible for global warming. Carbon dioxide, which contributes to being the single most significant greenhouse gasses emission, comes from the exhaust of an automobile. Catalytic converter plays a vital role in the reduction of such greenhouse gasses. The objective of the present study is to examine an automobile catalytic converter to present a detail and comprehensive report on the key parameters affecting the flow uniformity inside the converter and thus attempting to achieve minimum pressure drop across the converter to reduce the backpressure. The catalytic converter geometry is modified to increase the conversion efficiency of the converter. The results reported in the latter part of this paper gives a good insight about the recirculation zones created in the base and also velocity and pressure plots to find a solution for uniform flow within the monolith and also achieved a reduction in pressure drop of 3.7 Pa.

Keywords:

 Catalytic convertor; flow uniformity;
 recirculation zones; engine back pressure

Copyright © 2020 PENERBIT AKADEMIA BARU - All rights reserved

1. Introduction

The catalytic convertor geometry is as shown in Figure 1. Carbon monoxide (CO) is produced within exhaust when a rich air-fuel mixture is burnt within the combustion chamber [1]. Nitrous oxide appears mainly in the form of nitric oxide (NO) and nitrogen dioxide (NO₂); these gasses are responsible for acid rains.

* Corresponding author.

E-mail address: sakhan@iium.edu.my (Sher Afghan Khan)

<https://doi.org/10.37934/cfdl.12.9.116128>

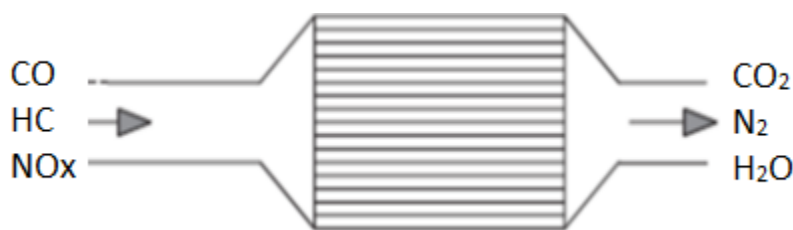

Fig. 1. Three-way catalytic converter [1]

The variables for the present study are the geometry of the inlet cone, placement of monolith, shape of the exit cone. Experiments with a catalytic converter for passenger cars show that a significant improvement of the conversion rate service life can be attained by uniform flow [2]. A new design of the monolithic substrate, in which the inlet face of the substrate is shaped to form a cone or a parabola, has been tested. The parameters used were the velocity flow uniformity index. Holmgren *et al.*, [3] pointed out the advantages of the design as the catalyst is more efficiently used, and the catalyst will be less deactivated.

The Enhanced Diffusion Header (EDH) converters and oblique diffuser converters with different configurations were designed and simulated by the CFD analysis. A Parameter study was abrupt expansion length on flow characteristics was investigated. Simulation results indicate that EDH and an oblique diffuser can improve the flow uniformity and decrease pressure loss in the converters [4]. Chakravarthy *et al.*, [5] showed that momentum unevenness cost by the recirculation zone certainly changes the comprehensive achievement of the monolith, especially during the cold- start transient operations . Hayes *et al.*, [6] pointed out that flow distribution under both reacting and non-reacting conditions is a dominant parameter of the convertor variables that is monolith cell density, diffuser angle, and aspect ratio. The authors studied the escalation in performance of the monolith attributed to converter length, cell densities, and metal loading. It was reported that by augmenting the monolith length, an increase in the light-off of carbon mono-oxide occurs. Light-off augmented with lower cell densities of monolith up to 20 CPI, due to lower thermal mass, also conversion efficiency increases at lower cell densities [7]. An experimental study was carried out by comparing a three-way catalytic converter of viz: Proton and Fiat type converter considering critical input parameters as cell density, substrate length, hydraulic channel diameter. The result showed augmentation of CO, NO_x, as the engine speed increases, Fiat converter has advanced in oxidizing the carbon mono-oxide. Conversion of hydrocarbon at 1000 rpm of fiat cover was at increased levels with comparison to proton converter [8]. Two different geometries full and reduced scale was numerically and experimentally analyzed, three critical locations with the converter were investigated. Due to the abrupt expansion of flow within the expander, considerable recirculation zones were created, making the flow non-uniform. Velocity profiles were generated by evaluating two velocities as 10.38m/s and 8.31 m/s; the curves plotted showed a proper parabolic curve expected for homogeneous momentum. It was concluded that momentum distribution is greatly influenced by momentum within the expander region and closely related to Reynolds number [9]. Experimental and numerical analysis was carried out to evaluate the dependence of local and average heat transfer characteristics on Reynolds number by using air-jet impingement laterally. As Reynolds number increases, the Nusselt profile curve shows the maximum value Nusselt number (Nu) was very closely related to the Reynolds number (Re) [10]. Two types of catalytic converter were studied one is closed coupled, and the other is underbody converters attributed to pressure decline and homogeneity index. The numerical analysis revealed a backward momentum in the expander region of the converter, indicating a non-homogeneous flow. The authors suggested optimization of inlet cone angle, but not provided any optimization regarding this [11]. Variables under study were converter length, cell

densities, and typical metal loading. The results showed that augmenting the monolith length boost light-off and maximum conversion. The maximum conversion efficiency is also increased up to 160 mm. Most of the researchers modeled the monolith as porous media, defining a relationship between the pressure and the resistances forces using the Ergun equation [12].

The study has an unambiguous and a tangible research gap to study, the inlet cone angle identified as the most influential parameter affecting the flow uniformity within the converter also not much data had been reported in literature. Due to implementation of BS-VI norms, much stringent norms had been enforced, in order to achieve this norms the performance improvement of catalytic converter is utmost necessary and had been done recently. The work had been carried forward in this paper to achieve performance parameter optimization of an automobile catalytic converter.

This paper aims to locate and evaluate the critical parameter affecting the momentum of velocity and pressure inside the converter and optimization of the inlet cone angle as identified most influential parameter justified in the latter part of the paper so that to achieve uniformity inflow, least pressure rise across the monolith. In the present research work, the catalytic converter is optimized for flow improvements, cost, and conversion of pollutants using CFD. In this analysis, a 3D geometry is modeled.

2. Geometry and Simulation

2.1 Model Characteristics

The catalytic converter components such as expander and diffuser, channel bricks are shown in Figure 2. Two different geometry are analyzed: (a) base model geometry and (b) variant 01 geometry. The central change with the previous efforts is that they established the catalytic converter as a permeable means [2,4]. Consequently, it was considered a multi-carrier component, as illustrated in Figure 2. It is, to a greater extent, an exact explanation of the existing geometry. The base design geometry consists of 100 CPSI. Figure 2 also indicates three sections (labeled A_1 , A_2 , and A_3) on which the momentum field is inspected in depth.

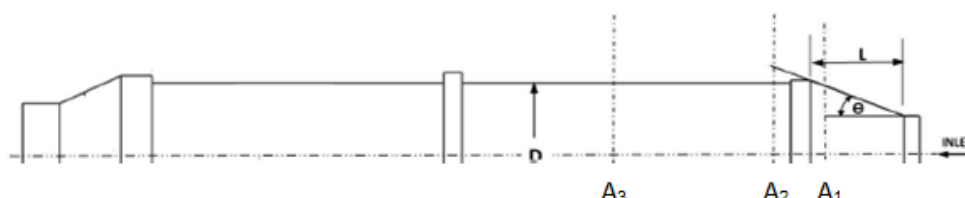

Fig. 2. The computational domain used for the simulation of the results

Figure 3 shows the various dimension of the actual geometry of the converter with inlet on the right-hand side. The first brick is of 60 mm length. This geometry is analyzed in depth in computational fluid modeling software STAR CCM+.

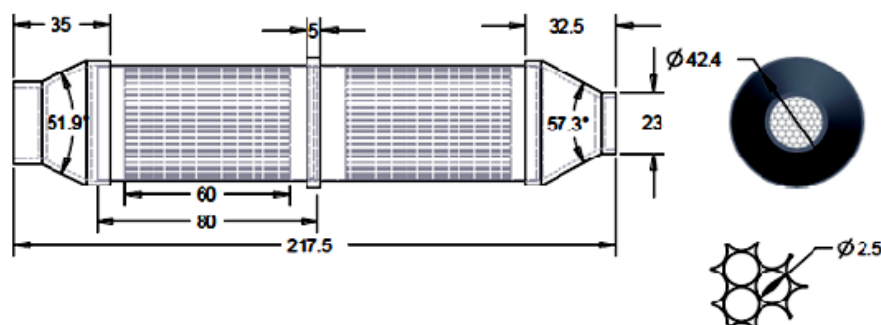

Fig. 3. Schematic representation of three-way automobile catalytic converter (All dimensions are in mm)

2.2. Boundary Conditions

At the inlet, to the catalytic converter, a velocity of 10.38 m/s and 8.31 m/s was considered. The inlet temperature is constant at 300 K. For 10.38 m/s situation, the Reynolds number (based on hydraulic diameter) inside every monolith carrier is $Re_{ch} = 378$. The stream at the inner side of the converter carrier is laminar; the movement in the estuary manifold is turbulent. The working conditions for the component are briefed in Table 1. The K-epsilon turbulent model was used for the analysis [13-16]. The k-ε model predicts the turbulent flow near-wall region and laminar flow very accurately in central channels of the monolith; considering the transition of flow from laminar to turbulent inside the monolith, the model accurately predicts the pressure and velocity field, which otherwise were inaccurately predicted by RNG k-ε, k-ω as justified various authors [17-33].

Table 1

Working conditions and variables for the catalytic convertor simulations

Brick carrier components	
brick length	60 mm
Carrier diameter	2.5 mm
Wall thickness	0.10 mm
Mean momentum	2.5 m/s
Channel Reynolds number	378
Inlet velocity	V1 = 10.38m/s
Inlet velocity	V2 = 8.31m/s
Inlet Temperature	300 K
Pressure	1 atm

2.3 Inlet Velocity Calculation

The mean channel velocity of 2 and 2.5 m/s into an individual monolith route is used for the geometries. The inlet velocities are calculated for channel velocities of 2.0 and 2.5 m/s and found to be 8.31 and 10.38 m/s, respectively.

2.4 Model Validation

The results reported by Pushpavanam *et al.*, were used to validate the current study. They used 85 channels of the ceramic monolith with a wall thickness of 400 μm, the inlet diameter of 40 mm, diffuser length was 53 mm, and the inlet flow velocity was 10.63 m/s [9].

Figure 4 shows similar trends as reported by Pushpavanam *et al.*, [9] for the predicted velocity profile at location A2 first increasing and then decreasing. This indicates that the proposed model is realizable and be able to study the momentum characteristics of the converter with various configurations. The momentum circulation in the catalytic converter is analyzed with the help of the velocity profile and flow index.

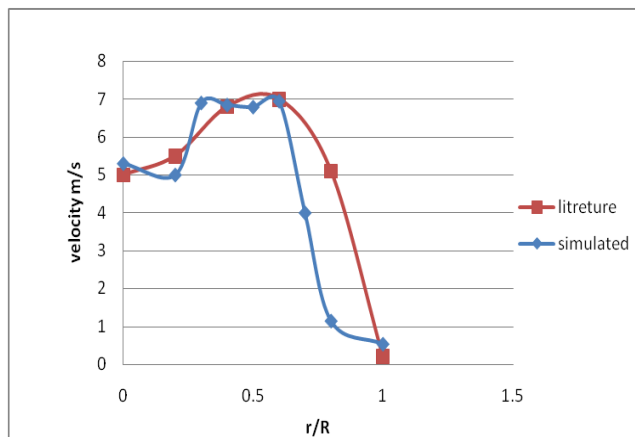

Fig. 4. Velocity magnitude Vs. Non-dimensional transverse coordinate at location A₂

3. CFD Computations Results

The mesh dependency test has been conducted for different mesh element sizes. The Table 2 shows the results obtained by the CFD analysis at various mesh element sizes.

Table 2
 The grid independence test

Mesh Max Size	Mesh Elements	Dimensionless Pressure
5	154	0.998922409
4	197	0.998167155
3	280	0.997727411
2	505	0.997640757
1	1660	0.997534706
0.8	2703	0.997698947
0.6	4968	0.997893122
0.4	12114	0.998344804
0.2	36500	0.998348192
0.1	146002	0.998358275

3.1 Pressure and Velocity Contours

The CFD analysis of the established model was carried out by plotting various velocity and pressure contours and analyzing the results for the same. The velocity contour in Figure 5 shows a uniform flow in the middle channels of the monolith; at the inlet of the monolith, red color indicates a maximum velocity of 8.7 m/s. The flow velocity is more uniform in the second brick of monolith (Right side brick).

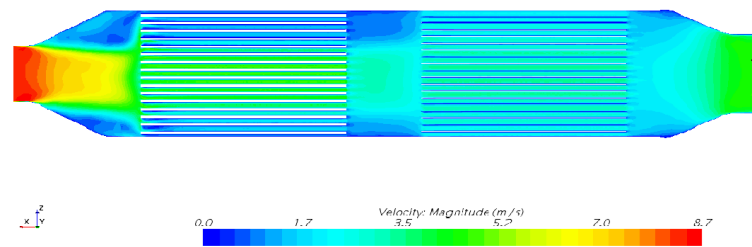

Fig. 5. Velocity contours at the midsection of catalytic converter for inlet velocity 8.31 m/s

Figure 6 shows the flow at the inlet of brick first is mal-disturbed due to sudden expansion in the flow into a number of channels present at starting of a monolith, also rise of pressure is maximum up to 62.2 Pa in this region, vortices are seen, which shows a non-uniform flow within the expander region, this uneven discharge leads in the decreased transformation efficiency of the converter. This indicates that the inlet cone angle design plays a critical role in the conversion efficiency of convertors and also affects flow uniformity inside the monolith.

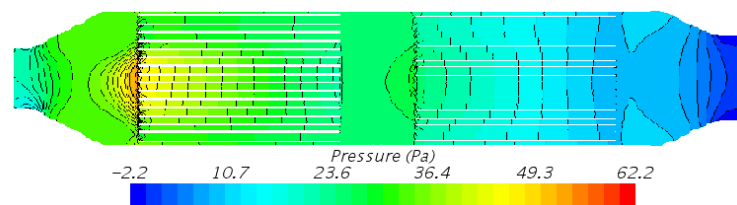

Fig. 6. Pressure contour at the midsection of catalytic converter for inlet velocity 8.31 m/s

Figure 7 shows a clear view of vortices created near the circumference of the inlet cone, which is the leading cause of non-uniform flow within the inlet expander; this will cause a reverse flow in this region, affecting the parabolic nature of the velocity profile. This vortex has to be reduced to have more uniform flow within the monolith; this also suggests an improvement in cone angle design to have a more consistent flow, and thus increase conversion efficiency rates.

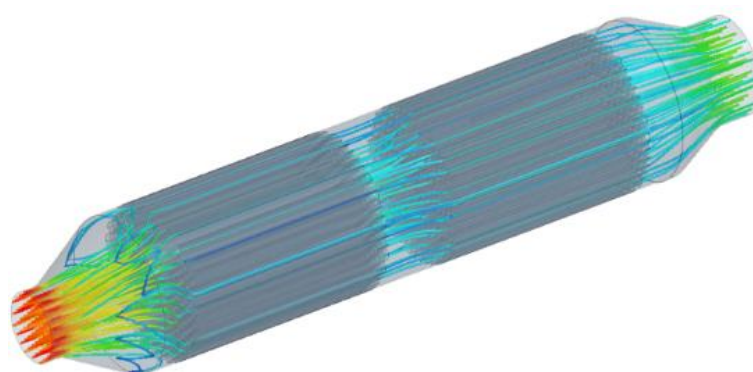

Fig. 7. streamline velocity plot for 8.31m/s

Figure 8 shows velocity contours at the mid-section of the catalytic converter for inlet velocity of 10.38 m/s. It offers similar results as discussed for inlet velocity of 8.31 m/s shown in Figure 5. The flow in the middle channels of the monolith is more uniform; also, there is a recirculation zone created near the walls of the inlet cone shown. Also, there is an inactive zone present near the walls of the inlet cone represented by blue color responsible for non-uniformity within the flow.

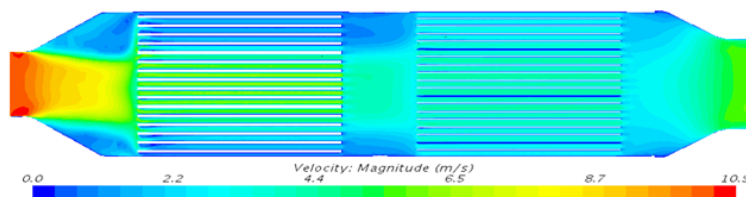

Fig. 8. Velocity contours at mid-section of catalytic converter for inlet velocity 10.38 m/s

Figure 9 shows a clear view of recirculation zones near the walls of the inlet cone represented with green color, and also rise of pressure is high up to 88.3 Pa; this will define a non-uniform flow with the base design with cone angle 57.3° . From Figure 7, 8, and 9, there are pieces of evidence of non-uniform, highly mal-disturbed flow, which will affect the conversion efficiency and also extra back pressure due to high pressure within the convertor.

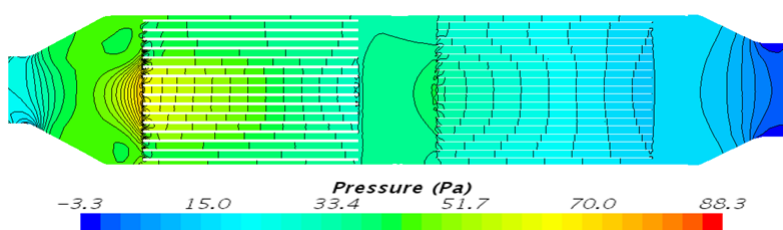

Fig. 9. Pressure contour at the midsection of catalytic converter for inlet velocity 10.38 m/s

A plane viz: A, is defined along the axis of the geometry, at the center of the first brick transversely and at the center of the second brick transversely, respectively. The velocity plot for inlet velocity of 10.38 m/s indicates the blue region, which is term as inactive zones in turn; these stagnant zones increase flow mal-distribution, as shown in Figure 10.

Figure 10(a) shows that the flow is concentrated at the central region inside the monolith channels, so there is an uneven mass flow rate distribution within the monolith channels. The blue region indicates inactive zones. Figure 10 (b) shows that in the variant 01 model, the flow inside the monolith channel is more consistently distributed as compared to the other model; also, the inactive zones are reduced, which is termed as non-uniformity.

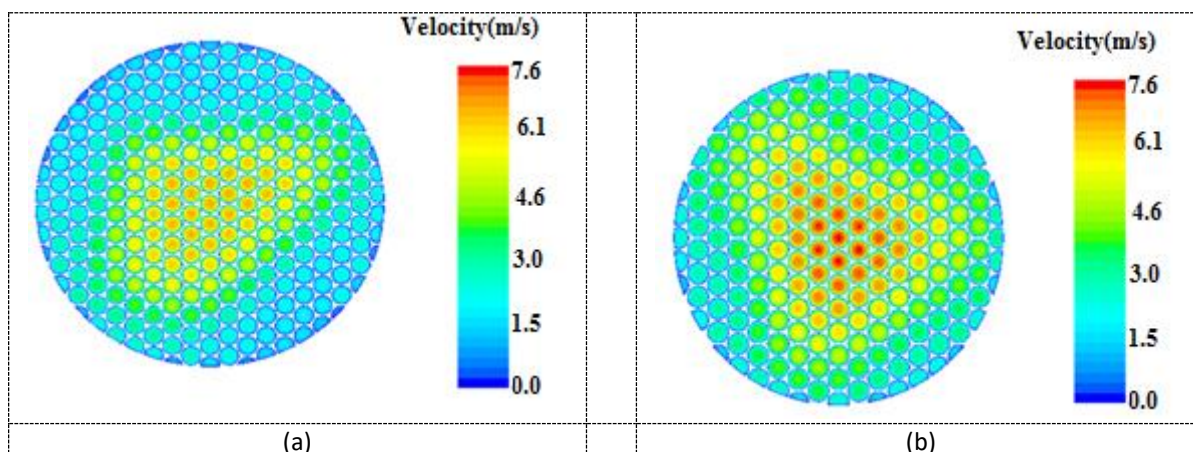

Fig. 10. Velocity contour at plane A for inlet velocity of 10.38 m/s (a) Base Model: Cone Angle = 57.3° (b) Variant 01: Cone Angle = 57.3°

3.2 Flow Distribution

Figure 11 shows the transverse velocity profile at various locations (A_1 , A_2 , and A_3) in the base model design for an entrance momentum of 10.38 m/s. The curves show peak momentum at the center and zero at the walls. The correct parabolic velocity profile is not followed, as seen from the graph, required for laminar momentum; this is the probable cause of uneven momentum circulation within the catalytic convertor.

The analysis of the flow distribution is repeated for a lower inlet velocity of 8.31 m/s, as shown in Figure 12. The uneven momentum circulation is higher at location A_1 at the inlet diffuser as compare to location A_2 and location A_3 .

Figure 12 shows the maximum velocity is 6.68 m/s at the center; this value is lower as compared to the maximum velocity corresponding to 10.38 m/s. This shows that for higher inlet velocities (higher mass flow rate) gives rise to stronger recirculation pattern in the inlet cone, due to which the flow becomes more non-uniform across the channels.

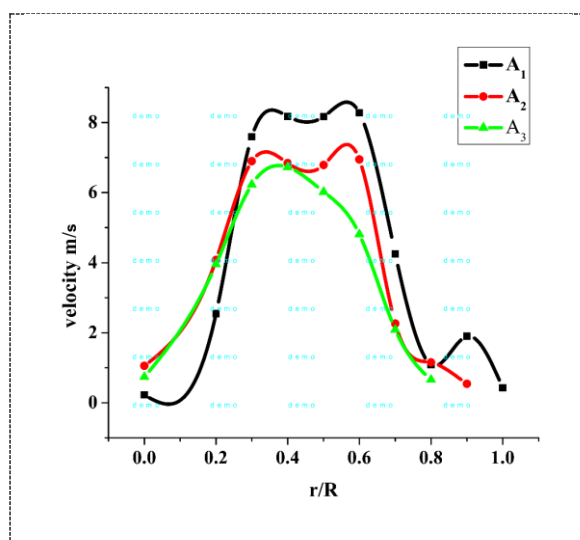

Fig. 11. Significance of momentum Vs. dimensionless distance in the radial direction at 10.38 m/s

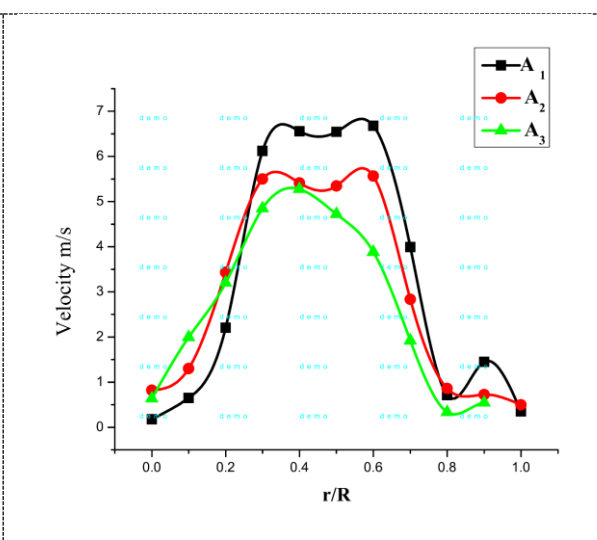

Fig. 12. Significance of momentum Vs. dimensionless distance in the radial direction for 8.31 m/s

3.3 Pressure Effects

Figure 13 shows the significance of pressure magnitude Vs. dimensionless radial co-ordinates for 10.38 m/s. The maximum pressure is observed at location A_2 is 60 Pa. The pressure decrease across every carrier in the brick gives rise to pressure at the location A_2 .

The pressure drop across the catalytic convertor was found to be 66.4 Pa. As there is a need for more uniform flow across the convertor, keeping pressure drop minimum, certain modifications are suggested as per the literature review shown in Table 3.

Table 3
 Geometry modification of the catalytic converter

Model	Cone angle (Degrees)	Monolith brick length	Monolith brick Diameter	Inlet pipe Diameter	Inlet pipe length
Base Model	57.3	60	40	19	21.5
Variant 01 Model	45	70	37.03	19	28.35

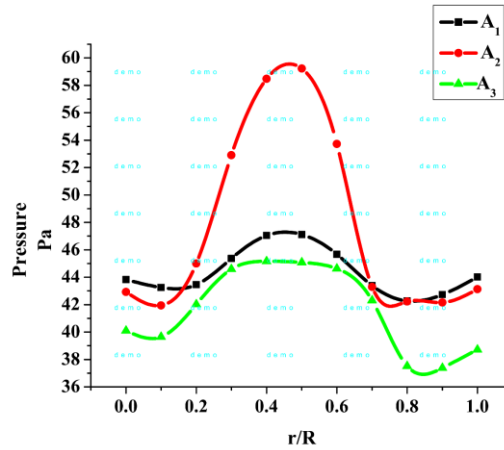

Fig. 13. Significance in pressure magnitude Vs. dimensionless radial co-ordinates for 10.38 m/s

3.4 Velocity and Pressure Distribution

The momentum circulation along the radial coordinate is further homogeneous, as illustrated in Figure 14. The variant 1 model velocity profile is following nearly a parabolic curve required for laminar flow. This indicates a more uniform flow within the convertor. The fluid momentum is completely laminar within the catalytic convertor.

The pressure drop characteristics are also studied by estimating the numerical values of pressure across the catalytic convertor. Figure 15 shows the pressure drop across the convertor for 8.31 m/s. It is found that the base design results in a total pressure drop across the convertor. It is 48.3 Pa for a cone angle of 57.3°. The pressure drop is reduced to 45.6 Pa for variant 03 cone angle 52.3°. Thus a pressure drop improvement of 3.7 Pa is achieved by modifying the geometry, which in turn will reduce the engine backpressure value, thus improving specific fuel consumption.

This shows that the estuary expander corner is the most critical parameter in designing the catalytic convertor.

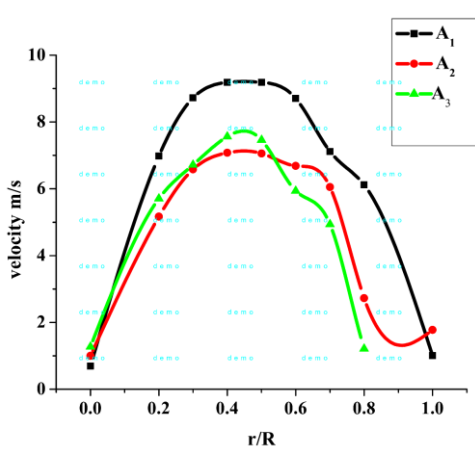

Fig. 14. Significance of momentum Vs. dimensional distance in the radial direction for 10.38 m/s

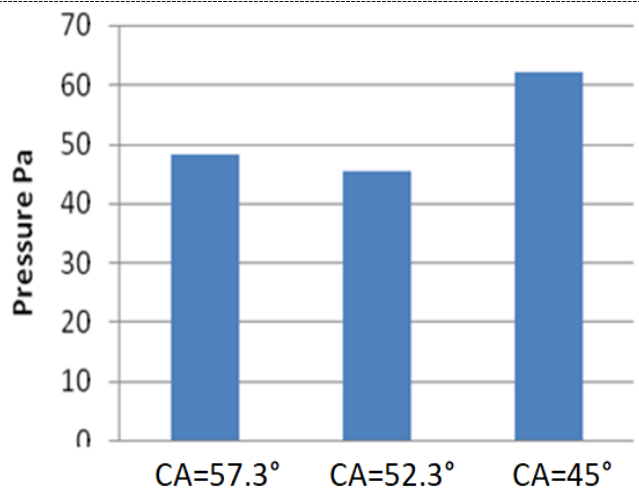

Fig. 15. Influence of diffuser angle on pressure drop corresponding to inlet velocity 8.31 m/s (CA = Cone Angle)

Figure 16 shows the growth in pressure in the transverse direction. The maximum increase in pressure is at 80 Pa at the A_2 location. The pressure drop across the variant 1 model is 84.9 Pa.

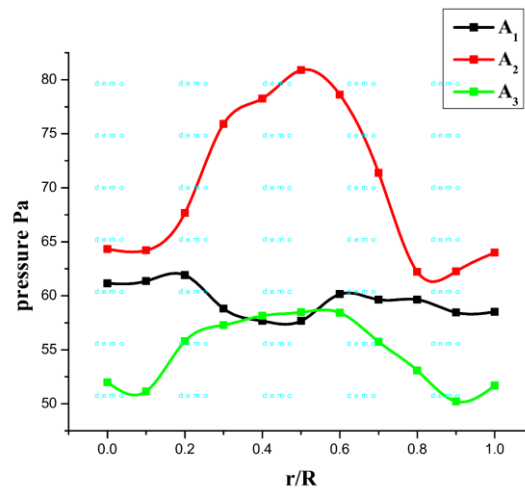

Fig. 16. Significance in pressure magnitude Vs. dimensionless radial for variant 1 model at 10.38 m/s

3.5 Flow Index Effect

A dimensionless parameter, flow uniformity index (γ), indicates the range of uneven momentum within the monolith carrier. Ideally, γ should be unity for no variable momentum within the converter. The flow index value is 1.8 at the center of the channels. This shows higher mass flow rates is concentrated at the center of the converter.

Figure 17 shows the flow index values. The flow index value is 1.6 at the center of the channel at location A_3 . Inside the convertor being, the flow is more uniform for a model for variant one as compare to the base design.

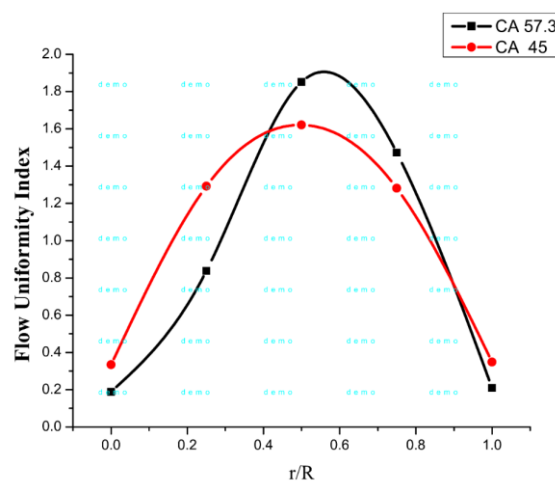

Fig. 17. Significance of flow index along with dimensionless transverse distance for 10.38 m/s at A_3 location

4. Conclusions

The flow distribution in a base design monolith is non-uniform due to the geometry of the inlet manifold and catalytic monolith. The base model velocity and pressure analysis in Figures 11, 12, 13 do not flow a Gaussian profile curve required for uniform flow inside the converter. Flow mal-distribution has reasonably significant effects on the conversion efficiency within the converter, mainly at higher flow rates. The optimization between consistent flow within the convertor and minimum pressure drop has to be selected. As seen from the results, the flow uniformity within the convertor is being optimized at the cost of the higher pressure drop as compared to base model geometry. Decreasing the diffuser angle below a particular value increases the pressure drop across the convertor. It is found that an optimum value of the diffuser angle for minimum pressure drop and uniform flow must be selected. The improvement in pressure drop characteristics is reported with an inlet cone angle of 52.3°. The reduction in pressure of 3.7 Pa is achieved for a 52.3° cone angle at the inlet. Hence there will be a reduction in backpressure and also a reduction in brake specific fuel consumption; the flow uniformity index is also improved by a value of 0.05 as compared to base design geometry. The performance improvement of a monolith is achieved, considering the above results. A transient response analysis of a monolith can be viewed in future work.

Acknowledgement

No declaration.

References

- [1] Theophil Sebastian Auckenthaler. "Modelling and Control of Three-Way Catalytic Converters." *A dissertation submitted to the Swiss Federal Institute of Technology Zurich* (2005).
- [2] Weltens, Herman, Harald Bressler, Frank Terres, Hubert Neumaier, and Detlev Rammoser. *Optimisation of catalytic converter gas flow distribution by CFD prediction*. No. 930780. SAE Technical Paper, 1993.
<https://doi.org/10.4271/930780>
- [3] Holmgren, Anna, Thomas Grönstedt, and Bengt Andersson. "Improved flow distribution in automotive monolithic converters." *Reaction Kinetics and Catalysis Letters* 60, no. 2 (1997): 363-371.
<https://doi.org/10.1007/BF02475700>
- [4] Shuai, Shijin, W. A. N. G. Jianxin, and Renjun Zhuang. *Numerical simulation and optimum design of automotive catalytic converters*. No. 2000-05-0309. SAE Technical Paper, 2000.
- [5] Chakravarthy, V. K., J. C. Conklin, C. S. Daw, and E. F. D'Azevedo. "Multi-dimensional simulations of cold-start transients in a catalytic converter under steady inflow conditions." *Applied Catalysis A: General* 241, no. 1-2 (2003): 289-306.
[https://doi.org/10.1016/S0926-860X\(02\)00490-8](https://doi.org/10.1016/S0926-860X(02)00490-8)
- [6] Hayes, R. E., Anton Fadic, Joeseeph Mmbaga, and A. Najafi. "CFD modelling of the automotive catalytic converter." *Catalysis today* 188, no. 1 (2012): 94-105.
<https://doi.org/10.1016/j.cattod.2012.03.015>
- [7] Subramanian, M., MK Gajendra Babu, and J. P. Subrahmanyam. *Optimization Of Catalytic Converter For Cost And Effective Conversion For Spark Ignition Engines*. No. 2004-28-0008. SAE Technical Paper, 2004.
<https://doi.org/10.4271/2004-28-0008>
- [8] Mohiuddin, A. K. M., and Muhammad Nurhafez. "Experimental analysis and comparison of performance characteristics of catalytic converters including simulation." *International Journal of Mechanical and Materials Engineering* 2, no. 1 (2007): 1-7.
- [9] Agrawal, Gaurav, Niket S. Kaisare, S. Pushpavanam, and Karthik Ramanathan. "Modeling the effect of flow mal-distribution on the performance of a catalytic converter." *Chemical engineering science* 71 (2012): 310-320.
<https://doi.org/10.1016/j.ces.2011.12.041>
- [10] Agrawal, Gaurav, Niket S. Kaisare, S. Pushpavanam, and Karthik Ramanathan. "Modeling the effect of flow mal-distribution on the performance of a catalytic converter." *Chemical engineering science* 71 (2012): 310-320.
<https://doi.org/10.1002/htj.21295>

- [11] CP, Om Ariara Guhan, G. Arthanareeswaren, and K. N. Varadarajan. "CFD study on pressure drop and uniformity index of three cylinder LCV exhaust system." *Procedia Engineering* 127 (2015): 1211-1218.
<https://doi.org/10.1016/j.ces.2011.12.041>
- [12] Muthaiah, PL S., and S. Sendilvelan. "CFD Analysis of catalytic converter to reduce particulate matter and achieve limited back pressure in diesel engine." *Global Journal of Research In Engineering* 10, no. 5 (2010).
<https://doi.org/10.4271/2011-01-1245>
- [13] Pathan, Khizar Ahmed, Prakash S. Dabeer, and Sher Afghan Khan. "Investigation of base pressure variations in internal and external suddenly expanded flows using CFD analysis." *CFD Letters* 11, no. 4 (2019): 32-40.
- [14] Pathan, Khizar Ahmed, Prakash S. Dabeer, and Sher Afghan Khan. "Influence of expansion level on base pressure and reattachment length." *CFD Letters* 11, no. 5 (2019): 22-36.
- [15] Khan, Sher Afghan, Abdul Aabid, Fharukh Ahmed Mehaboobali Ghasi, Abdulrahman Abdullah Al-Robaian, and Ali Sulaiman Alsagri. "Analysis of area ratio in a CD nozzle with suddenly expanded duct using CFD method." *CFD Letters* 11, no. 5 (2019): 61-71.
- [16] Pathan, Khizar Ahmed, Syed Ashfaq, Prakash S. Dabeer, and Sher Afgan Khan. "Analysis of parameters affecting thrust and base pressure in suddenly expanded flow from nozzle." *Journal of Advanced Research in Fluid Mechanics and Thermal Sciences* 64, no. 1 (2019): 1-18.
- [17] Umair, Siddique Mohammed, Abdulrahman Alrobaian, Sher Afghan Khan, Marthande Gnanagonda Kashinath, and Patil Rajesh. "Numerical Investigation of Critical Range for the Occurrence of Secondary Peaks in the Nusselt Distribution Curve." *CFD letters* 10, no. 2 (2018): 1-17.
- [18] Pathan, Khizar A., Prakash S. Dabeer, and Sher A. Khan. "Enlarge duct length optimization for suddenly expanded flows." *Advances in Aircraft and Spacecraft Science* 7, no. 3 (2020): 203-214.
- [19] Pathan Khizar Ahmed, S. A. Khan, and P. S. Dabeer. "An Investigation of Effect of Control Jets Location and Blowing Pressure Ratio to Control Base Pressure in Suddenly Expanded Flows." *Journal of Thermal Engineering* 6, no. 2 (2020): 15-23.
<https://doi.org/10.18186/thermal.726106>
- [20] Pathan, Khizar Ahmed, Prakash S. Dabeer, and Sher Afghan Khan. "Effect of nozzle pressure ratio and control jets location to control base pressure in suddenly expanded flows." *Journal of Applied Fluid Mechanics* 12, no. 4 (2019): 1127-1135.
<https://doi.org/10.29252/jafm.13.02.30049>
- [21] Pathan, Khizar Ahmed, Prakash S. Dabeer, and Sher Afghan Khan. "An investigation to control base pressure in suddenly expanded flows." *International Review of Aerospace Engineering (I. RE. AS. E)* 11, no. 4 (2018): 162-169.
<https://doi.org/10.15866/irease.v11i4.14675>
- [22] Pathan, Khizar Ahmed, Prakash S. Dabeer, and Sher Afghan Khan. "Optimization of area ratio and thrust in suddenly expanded flow at supersonic Mach numbers." *Case studies in thermal engineering* 12 (2018): 696-700.
<https://doi.org/10.1016/j.csite.2018.09.006>
- [23] Sher Afghan Khan, M. A. Fatepurwala, K. N. Pathan, P. S. Dabeer & Maughal Ahmed Ali Baig. "CFD Analysis of Human Powered Submarine to Minimize Drag." *International Journal of Mechanical and Production Engineering Research and Development (IJMPERD)* 8, no. 3 (2018): 1057-1066.
<https://doi.org/10.24247/ijmperdjun2018111>
- [24] Pathan Khizar Ahmed, S. A. Khan, and P. S. Dabeer. "CFD analysis of the effect of flow and geometry parameters on thrust force created by flow from nozzle." *2nd International Conference for Convergence in Technology (I2CT)*, (2017): 1121-1125.
<https://doi.org/10.1109/I2CT.2017.8226302>
- [25] Pathan Khizar Ahmed, S. A. Khan, and P. S. Dabeer. "CFD analysis of the effect of area ratio on suddenly expanded flows." *2nd International Conference for Convergence in Technology (I2CT)*, (2017): 1192-1198.
<https://doi.org/10.1109/I2CT.2017.8226315>
- [26] Pathan Khizar Ahmed, P. S. Dabeer, and S. A. Khan. "CFD analysis of the effect of Mach number, area ratio, and nozzle pressure ratio on velocity for suddenly expanded flows." *2nd International Conference for Convergence in Technology (I2CT)*, (2017): 1104-1110.
<https://doi.org/10.1109/I2CT.2017.8226299>
- [27] Khan, Sher Afghan, and Ethirajan Rathakrishnan. "Control of suddenly expanded flow from correctly expanded nozzles." *International Journal of Turbo and Jet Engines* 21, no. 4 (2004): 255-278.
<https://doi.org/10.1515/TJJ.2004.21.4.255>
- [28] Sajali, Muhammad Fahmi Mohd, Abdul Aabid, Sher Afghan Khan, Fharukh Ahmed Ghasi Mehaboobali, and Erwin Sulaeman. "Numerical investigation of flow field of a non-circular cylinder." *CFD Letters* 11, no. 5 (2019): 37-49.

-
- [29] Khan, Sher Afghan, Abdul Aabid, and C. Ahamed Saleel. "Influence of micro jets on the flow development in the enlarged duct at supersonic Mach number." *International Journal of Mechanical and Mechatronics Engineering* 19, no. 01 (2019): 70-82.
- [30] Asadullah, Mohammed, Sher Afghan Khan, Waqar Asrar, and E. Sulaeman. "Low-cost base drag reduction technique." *International Journal of Mechanical Engineering and Robotics Research* 7, no. 4 (2018): 428-432.
<https://doi.org/10.1515/TJJ.2004.21.4.255>
- [31] FAG, M., and S. A. Khan. "Active Control of Base Pressure using Micro Jets for Area Ratio of 7.56." *International Journal of Innovative Technology and Exploring Engineering* 8, no. 6 (2019): 491-495.
- [32] Khan, Ambareen, Nurul Musfirah Mazlan, Mohd Azmi Ismail, and Mohammad Nishat Akhtar. "Experimental and Numerical Simulations at Sonic and Supersonic Mach Numbers for Area Ratio 7.84." *CFD Letters* 11, no. 5 (2019): 50-60.
- [33] Khan, Sher Afghan, Abdul Aabid, Imran Mokashi, and Zaheer Ahmed. "Effect of Micro Jet Control on the Flow Filed of the Duct at Mach 1. 5." *International Journal of Recent Technology and Engineering (IJRTE)* 8: 1758-1762.
<https://doi.org/10.35940/ijrte.B1148.0882S819>