



Implementation of Control Valves System on Microturbine Drone's Rotational Motion

Muhammad Nor Ikmal Muhamad Nazri¹, Adi Azriff Basri^{1,2,3*}, Ernie Illyani Basri¹, Spoorthi Singh⁴

¹ Department of Aerospace Engineering, Faculty of Engineering, Universiti Putra Malaysia, 43400, Serdang, Selangor, Malaysia

² Aerospace Malaysia Research Center (AMRC), Universiti Putra Malaysia, Selangor, Malaysia

³ Laboratory of Biocomposite Technology, Institute of Tropical Forestry and Forest Products (INTROP), Universiti Putra Malaysia, Selangor, Malaysia

⁴ Department of Mechatronics Engineering, Manipal Institute of Technology, Manipal, India

ARTICLE INFO

ABSTRACT

Article history:

Received 8 October 2024

Received in revised form 7 November 2024

Accepted 21 November 2024

Available online 30 November 2024

Keywords:

Control valves; microturbine; solenoid valves; drone's control system; pulse width modulation

The drone technology has received a wide range of research focusing on improving flight dynamics, battery life, payload capacity and sensor technology. However, for the applications of using drone for high rise buildings are limited by battery life for longer flight with longer duration tasks. This work presents the implementation of a control valve systems for the rotational motion of a microturbine drone. The first objective of this project was to design and develop a control valve system for a microturbine with propeller. The second objective was to measure micro turbine's performance output which consisted of revolution per minute (rpm) and voltage (V) produced with the control valves system. The final objective was to verify the effectiveness of the control valve system by measuring the differences of the turbine speed of each turbine on the quadcopter to conceptually control the rotational motion of the drones. In conclusion, this work demonstrated the concept of the developed control valve system that can control the rotational motion of the drone.

1. Introduction

A typical drone is powered by batteries. The problem arises from using the batteries as the power sources is the drone cannot sustain for so long in the air. Due to the limited capacity of the batteries used in drones, their flight time is also limited [1]. A typical drone battery has an approximate average runtime of 20 minutes [2]. This problem will become the limitation for the drones to be applied for some longer duration tasks such as to paint high rise buildings, etc. So, the main idea is to replace the drone from battery powered using DC Motor to micro turbine application for the drone. The next problem from the ideas is on how to control the dynamics of the drone. Compared to the battery powered drone before, the amount of power delivered to each motor will determine the motion of the drone. Due to its complicated structure, modelling a quadcopter is not a simple task. The goal

* Corresponding author.

E-mail address: adiazriff@upm.edu.my

<https://doi.org/10.37934/ard.122.1.4659>

was to create the most realistic vehicle model possible. Quadcopters have four input forces, namely thrust forced generated by four propellers.

There are two types of propeller configurations, which are “+” and “x”, as in Figure 1. It is expected that a quadcopter with “x” configuration is more stable than a quadcopter with the “+” configuration. In hover flight, propellers 1 and 3 rotate counterclockwise, while propellers 2 and 4 rotate clockwise. The Newton’s Third Law states that this process is necessary to account for the effect of action/reaction [3]. To change the pitch angle of a quadcopter, different amounts of thrust at front and rear rotors can be given, while maintaining the overall thrust. To change the roll angle, different amounts of thrust can be given to both left and right rotors. To change the yaw angle, counterthrust can be applied differently to each pair of rotors (1 and 3 or 2 and 4). To move counterclockwise, it required to increase the speed of the counterclockwise propeller, while decreasing the speed of clockwise propeller and *vice versa* for clockwise movement. It is important to maintain the total thrust while making all these changes to avoid ups and downs movement [4]. So, for micro turbine drone the concept will be the same but the approach will be different. The speed of each propeller can be controlled by the rotational speed of the turbine. To control the rotational speed of the turbine, another problem must be tackled which is to control mass flow rate of the inlet air using control valves system.

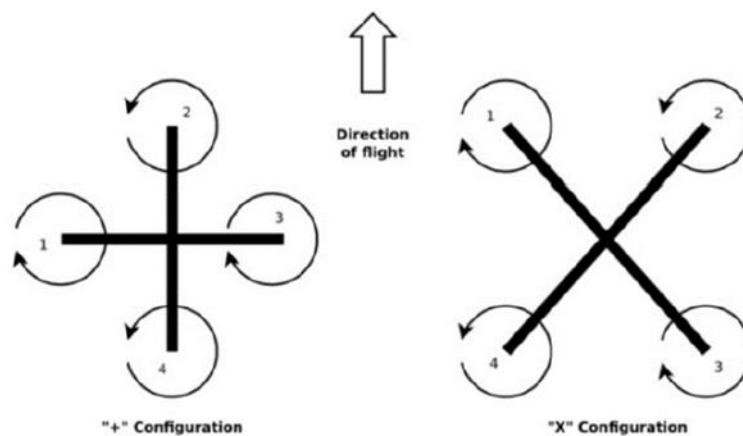

Fig. 1. Two main types of quadcopter configuration [3]

In real world application, speed governor was used to control the speed of the turbine especially hydro powered turbine. A speed governor for a turbine is a critical control mechanism designed to maintain the turbine's rotational speed within specified limits, ensuring stable operation and preventing overspeed conditions that could lead to mechanical failure or safety hazards [5]. The governor functions by adjusting the input energy to the turbine based on real-time speed measurement. Control valve is a mechanical device that regulates the flow of fluids (gases and liquids) by opening, closing, or partially obstructing passages in a pipe or duct. The speed governor of a hydroturbine typically includes a control valve as a crucial component [6]. Control valves are commonly used in a variety of industries, such as oil and gas, chemical processing, power generation, water treatment and many others. They are typically used to control process variables such as flow, pressure, temperature and liquid level.

The control valves can be used on the drone. The function of control valves is to control the flow of compressed air into the inlet of the micro-turbine, which allows the rotational speed of the microturbine to be controlled to a certain speed. It is important to be applied during pitching, rolling and yawing of the drone. There are several types of control valves with different shapes, sizes and

designs to meet the specific requirements of the application. For hydroturbines speed governors, wicket gates, guiding vanes and needle valves are the most often utilized valve types [7]. These valves are essential for controlling the water flow into the turbine, which in turn controls its speed and guarantees peak performance. For steam turbine, solenoid valves can be used in auxiliary roles within the control systems of turbines, such as in hydraulic circuits or for rapid on/off control in pneumatic system [8,9]. Their ability to quickly switch states makes them useful for applications requiring fast response times, but they lack the precision needed for continuous flow regulation in speed governors [10]. Several research papers have discussed on using the solenoid valves as the control valves of the turbine for various applications. The research investigates the use of high-speed solenoid valves for controlling gas flow in gas turbines [11]. The study includes a detailed analysis of the valve dynamics, response time, and the impact on turbine performance. Results indicate that solenoid valves can provide precise and rapid control, enhancing the overall efficiency and stability of gas turbine operations.

Pulse-width modulation (PWM) enhances solenoid valve response times through several key mechanisms. The first one is rapid switching. PWM operates by rapidly turning the solenoid on and off, which allows for quicker adjustments in the valve's position. This fast switching reduces the time the solenoid spends in transition states, leading to improved responsiveness [12-14]. Second is controlled current flow, by varying the duty cycle (the ratio of the on-time to the total cycle time), PWM can control the average current flowing through the solenoid. This allows for precise control over the solenoid's magnetic force, enabling it to respond more quickly to control signals [15-18].

Through real-time programming, [19] implement PWM method in pneumatic systems allows for the use of quick and affordable on/off valves in closed-loop control applications that are integrated to digital systems [19]. Wongsathon *et al.*, [20] studied the frequency of pulsating from 0 to 10 Hz using a solenoid valve to see the effect on flame jet on flow and heat transfer characteristics. These technologies can provide actuation properties at a far lower cost than electromechanical actuation systems. However, precise control is difficult to achieve because of the solenoid valves' significant delay time and unique on/off feature [21].

Based on the literature reviews above, most of the studies focusing on using the solenoid valves system in gas turbine. There is significant gap of using the control valves system in controlling the speed of the microturbine, hence regulating the speed of the drone's propellers for rotational motion. So, this paper have developed a control valves system using the solenoid valves to regulate the speed for all microturbines and propellers.

2. Methodology

The development phase will concentrate on choosing the right microcontroller, relay, and valve. To determine how well the control valve system manages turbine speed and voltage, it will first be tested on a single turbine. If it doesn't work, the design will be redone; if it works, the system will be integrated into the quadcopter frame, which includes wiring, hose installation, and valve placement. A leak test and component inspection will then follow. A tachometer will then be used to measure the turbine RPM in order to simulate propeller speed changes and assess speed variations. At this research conclusion, successful results will be examined and discussed, while any problems will be brought back to assembly checks.

2.1 Control Valves System Setup

The purpose of the control valve system was to manage the turbines' speed by controlling the inlet flow rate of four valves. A 5V Direct Current (DC) relay that serves as an electromagnetic switch, enabling the low-power control signal from the Arduino to operate higher-power circuits; solenoid valves that precisely control the flow of fluids by opening and closing as needed; a transmitter that sends activation signals to the solenoid valves, either wirelessly or through a wired connection; a receiver that receives the signal from the transmitter and relays it to the Arduino Uno, establishing effective communication within the system; and the Arduino Uno, which serves as the system's central microcontroller and processes input and output signals to control various tasks.

The signal from the transmitter triggers the Arduino Uno to produce a PWM signal, which is subsequently transmitted to the relay, as seen in Figures 2 and 3. The relay controls the power supply to the solenoid valves by switching its internal contacts in response to this control signal. This configuration efficiently controls fluid flow by enabling the valves to open in accordance with the designated duty cycle. Through the integration of the transmitter and receiver, the system enables remote control of the solenoid valves. The Arduino Uno and relay coordinate the opening process in response to the duty cycle of the PWM signal.



Fig. 2. Flowchart of control valves system

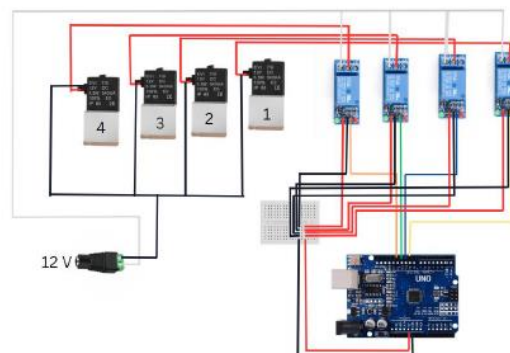

Fig. 3. Control valves system circuit diagram

2.2 Control Valves System Integration with Quadcopter

Several essential parts are used in the construction of the quadcopter. Because it can transform fluid movement, like air or exhaust fumes, into rotational motion that powers a rotor with electromagnets, a Micro Pelton Turbine has been chosen. These electromagnets create a magnetic field while the rotor rotates, which interacts with stationary wire coils to produce an electrical current. In this setup, a 7-inch propeller is attached to the turbine by a shaft, which facilitates thrust creation while the turbine turns and ensures frame compatibility.

The propellers are made to generate lift and propulsion through airflow. All parts of the drone are supported by the frame, which acts as its structural core. The F330 quadcopter frame was chosen for its compact design, which aligns well with the size of the propeller and overall system requirements. The control system of the four valves was integrated and assemble with quadcopter. Three 6 mm hose T joint was used to divide the hose to four ways from the source. As can be seen in Figure 4, each 6 mm hose was connected to the inlet of the micro turbine. Each solenoid valves were place below the quadcopter arms and relay was placed above it.

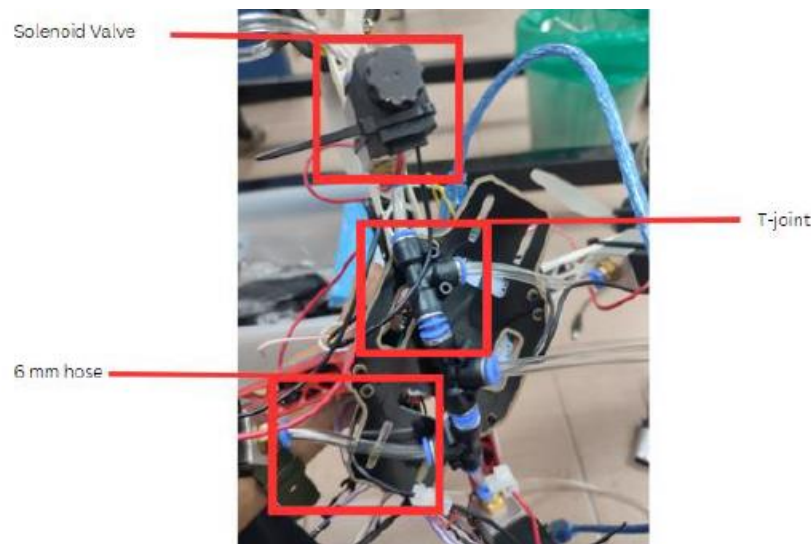

Fig. 4. Hose connection on quadcopter frame

2.3 Experiment on the Microturbine Performance without and w5 Experimental Analysis of Micro Turbine Voltage Production with Increasing Inlet Air Pressure with and without Propeller (1 ways) ith Propeller (1 Ways)

A set of tests was conducted to investigate the performance of the microturbine when the air pressure was applied. The first test was conducted to study the relationship between the inlet air pressure and revolutions per minute of the turbine with and without propeller. The setup of the experiment can be seen in Figures 5 and 6.

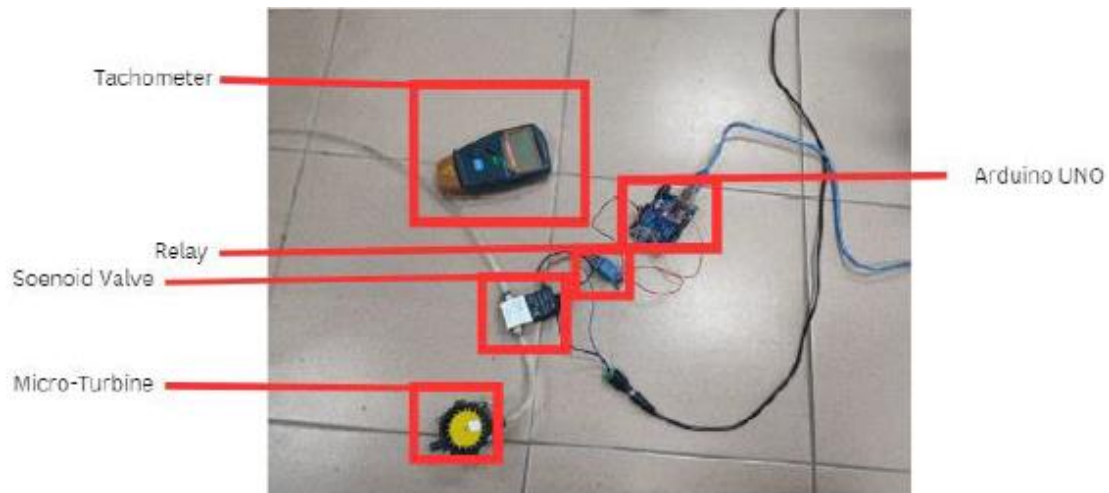

Fig. 5. Test setup for rotational speed measurement of turbine without propeller

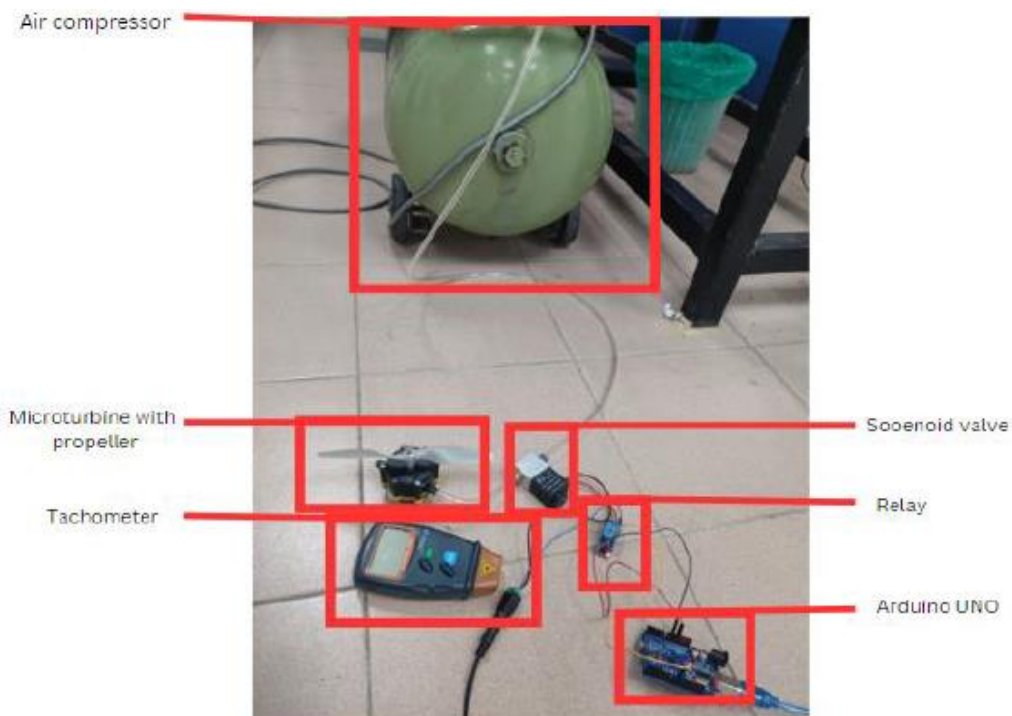

Fig. 6. Test setup for rotational speed measurement of turbine with propeller

2.4 Experimental Analysis of Micro Turbine Voltage Production with Increasing Inlet Air Pressure with and without Propeller (1 ways)

The objective of this experiment is to examine how the voltage production in a micro turbine system is affected by the increase in inlet air pressure. Base on Figure 7, consists of a micro turbine unit, a mechanism for controlling the inlet air pressure, and a voltmeter for measuring the generated voltage. The experiment involves systematically raising the inlet air pressure in predetermined steps and noting down the corresponding voltage readings. For comparison, the test was repeated with the addition of 7 inches propeller. To ensure precision and dependability, multiple measurements are taken at each pressure level.

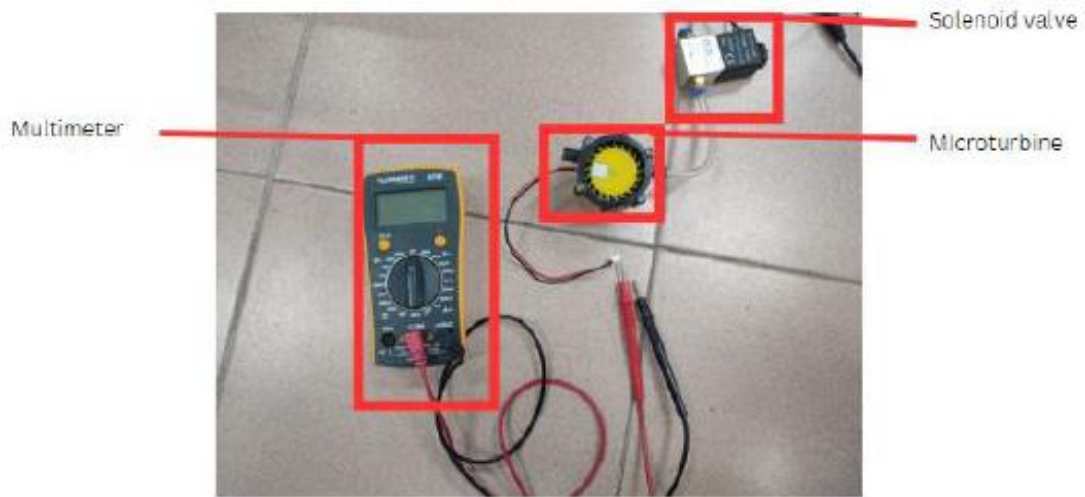

Fig. 7. Setup for voltage reading

Before the continuation to the 4 valves system, one simple control valve was fabricated consisting of a solenoid valves, one relay and an Arduino Uno. The data taken from this experiment is the micro turbine’s rotational speed. The valves will open and close to different duty cycle (0, 10, 20, 30, 40, 50, 60, 70, 80, 90, 100) %. The inlet pressure was set to a constant 60 psi. Different open and close duration in a minute was setup so that the variation of duty cycle can be implemented. The open and close time was setup based on Table 1 hence generate the duty cycle. The rotational speed of the turbine has been taken by tachometer for each duty cycle.

Table 1
 Duration of open and close and duty cycle

Duration (ms)		Duty Cycle (%)
Open	Close	
0	500	0
50	450	10
100	400	20
150	350	30
200	300	40
250	250	50
300	200	60
350	150	70
400	100	80
450	50	90
500	0	100

A set of tests has been conducted to measure the changes of each turbine speed on the quadcopter. Because of the inlet air pressure of 8 bar from an air compressor was not enough to run all four turbines at a time, two turbines were run by using an air compressor. This mean that Turbine 1 and 3 was run by an air compressor and Turbine 2 and 3 was ran by another compressor as shown in Figure 8. Both air compressor was open until the inlet pressure at 4 bar for a constant variable.

After that, initial speed of each turbine was measured and recorded by the tachometer. Then, to test the control valves system, the duty cycle of 80 % have been applied on each solenoid valves by the Arduino and the transmitter. Based on Figure 8, for example, firstly, solenoid valve 1 that responsible for controlling turbine 1 undergo open and close rapidly at duty cycle of 80 % (400 ms open and 50 ms close) for ten seconds. Then, the turbine speed of Turbine 1 and Turbine 3 was

measured. Next, solenoid valve 3 that responsible for controlling Turbine 3 will undergo the duty cycle of 80 % and the turbine speed of Turbine 1 and 3 was recorded again. The reading was taken 10 times. The same process was repeated for Turbine 2 and 4.

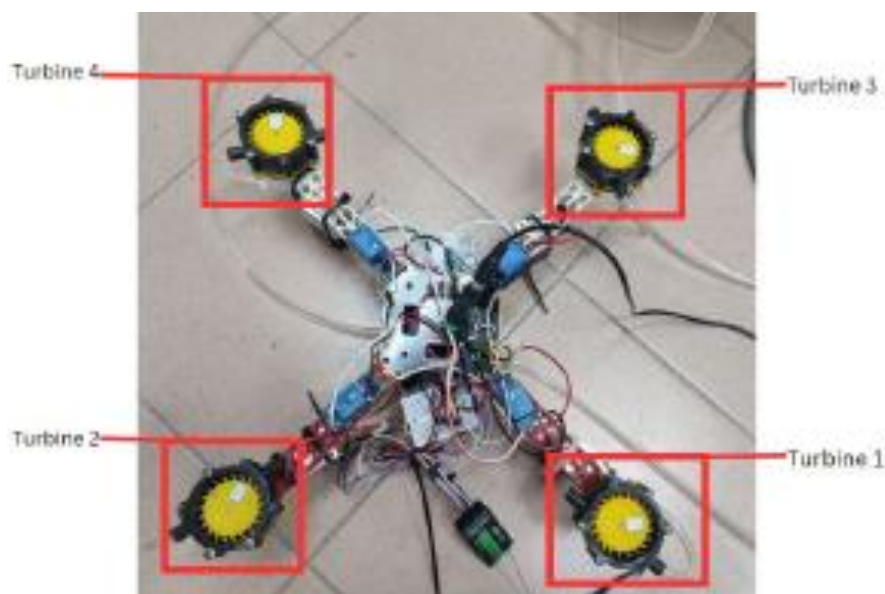

Fig. 8. Setup of turbine drone for testing

3. Results

3.1 Microturbine Performance without and with Propeller

3.1.1 Turbine inlet pressure and revolution per minute (rpm) of turbine with and without propeller

Based on Figure 9 Inlet air pressure and rpm of turbine with and without propeller. Relationship between the inlet pressure and number of rotations of the turbine is proportional for both without and with propeller. As the blades rotate faster, they create a lower-pressure region at the inlet, which encourages more fluid or gas to flow into the turbine. Consequently, an increase in the inlet pressure results in a higher force on the blades, causing them to rotate at a faster rate. For turbine without propeller, at lowest inlet value of 20 psi, the rpm of turbine stated to be 10,000 rpm while at highest inlet value of 60 psi, the rpm of turbine stated to be 23,000 rpm. Similarly, in a turbine with a propeller, the propeller serves to accelerate the fluid or gas as it flows through the turbine. As the inlet pressure increases, more fluid or gas is pushed through the propeller, generating a greater rotational force on the blades. This increased force leads to a higher number of rotations. For turbine with propeller, at lowest inlet value of 20 psi, the rpm of turbine stated to be 1,490 rpm while at highest inlet value of 60 psi, the rotational speed of turbine stated to be 4,100 rpm.

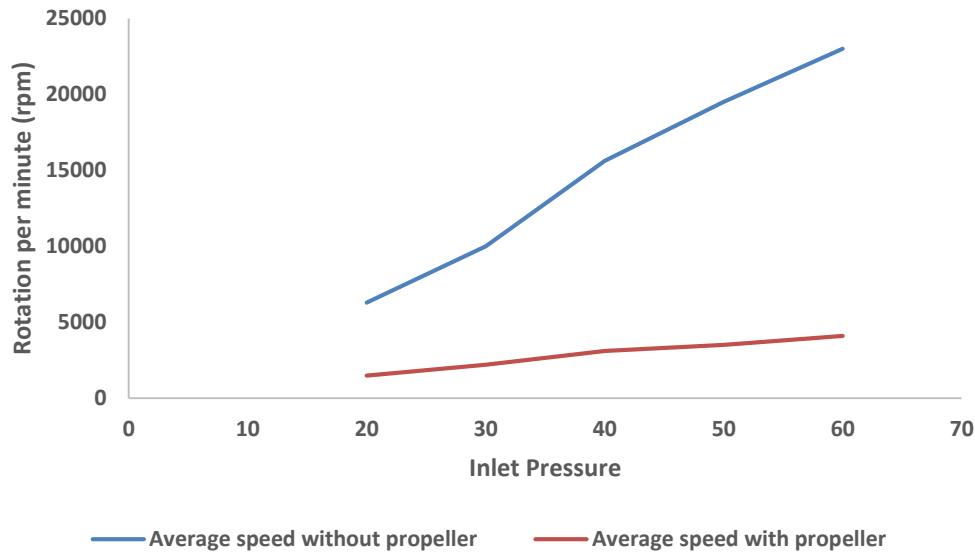

Fig. 9. Inlet air pressure and revolution per minute (rpm) of turbine with and without propeller

Meanwhile, Table 2 shows the rotational speed drop due to the implementation of propeller at the turbine. It can be observed that the percentage of speed drop shows quite high between the turbine without propeller and turbine with propeller. On average, it can be concluded that the introduction of turbine with propeller has reduced around 79.75 % of rpm. However, the differences can be observed from the differences of rpm between without and with propeller. A turbine with propeller has less rpm compared to propeller-less turbine at same inlet pressure. The results in Figure 16 show that at maximum inlet pressure of 60 psi, the maximum rpm value for turbine without propeller is stated to be 23,000 while turbine with propeller is stated to be 4,100 rpm. Meanwhile, based on Table 2, the average speed drop between turbine without propeller and turbine with propeller is stated to be 79.75 %. These results show that adding a propeller to a turbine increases the load on the turbine's rotor. The propeller blades create resistance that must be overcome, requiring additional energy for rotation. This extra load affects the torque output of the turbine. Generally, the presence of a propeller increases the torque demand on the turbine. To maintain the desired rotational speed, the turbine needs to generate a higher torque.

Table 2

Percentage rotational speed drop due to the implement of propeller

Inlet Pressure (psi)	Rotational speed without propeller (rpm)	Rotational speed with propeller (rpm)	Percentage Rotational speed drop (%)
20	6300	1490	76.35
30	10000	2200	78
40	15635	3100	80.17
50	19495	3500	82.05
60	23000	4100	82.17
Total Average			79.75

3.2 Control Valves System on the Turbine Performances

Figure 10 shows the rotational speed versus percentage of duty cycle of the turbine with propeller. It can be observed that the graph pattern shows significant increment of rpm when the percentage of duty cycle increase. At minimum duty cycle of 10 %, the rpm produce from the turbine with propeller is stated to be 5,290 rpm. The rpm shows increment when the percentage of duty

cycle increase and reach its peak at 100 % duty cycle with 13,680 rpm value. Based on these results, it shows that by changing the duty cycle of the valve, the rpm of the turbine can be controlled. When the valve in the turbine inlet remains open for a longer duration with a higher duty cycle, it permits a larger volume of compressed air to enter the turbine. This increased flow rate can potentially elevate the pressure within the system. Consequently, the greater flow rate and pressure exert a stronger driving force on the turbine, leading to an increase in its speed.

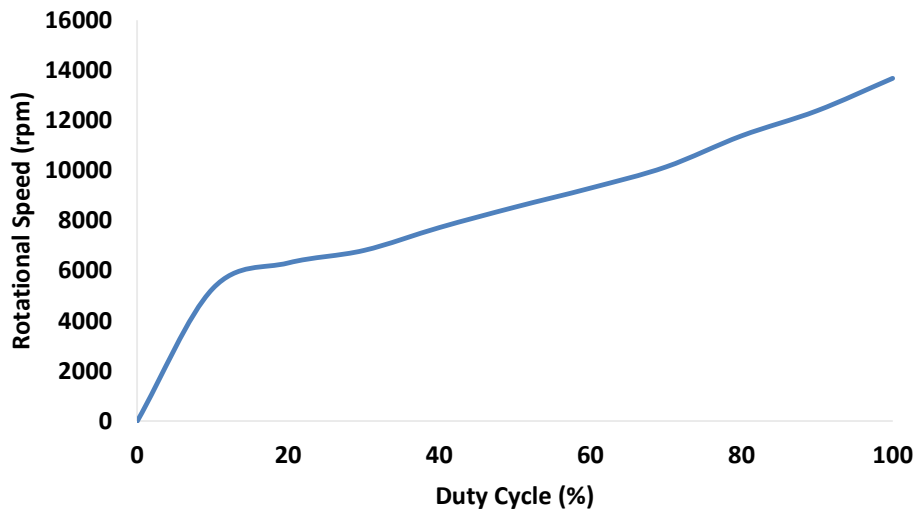

Fig. 10. Valve Duty Cycle vs Rotational speed of turbine

3.3 Control Valves System on Turbines Rotational Speed on Quadcopter

Based on Figure 11, with 4 bar inlet pressure into the turbine 1 and turbine 3, the inlet pressure was balanced as the speed for both turbines was the same on the beginning which was around 2700 rpm for each turbine. When input was applied for valve 1 at $t = 10s$, the turbine speed was changes for both turbine 1 and 3. For turbine 1, the speed was around 3100 and for turbine 3, the speed drop to 2100. This makes the speed differences between the turbines to be around 1000. After that, at $t = 20 s$, the input was applied for valve 3, making the speed for turbine 3 increases to 3255 and turbine 1 decreased to 2100, thus making the speed differences between the two turbines to be around 1100 rpm. The pressure difference between the two turbines was constant at average 1000 rpm showing that the system was quite stable.

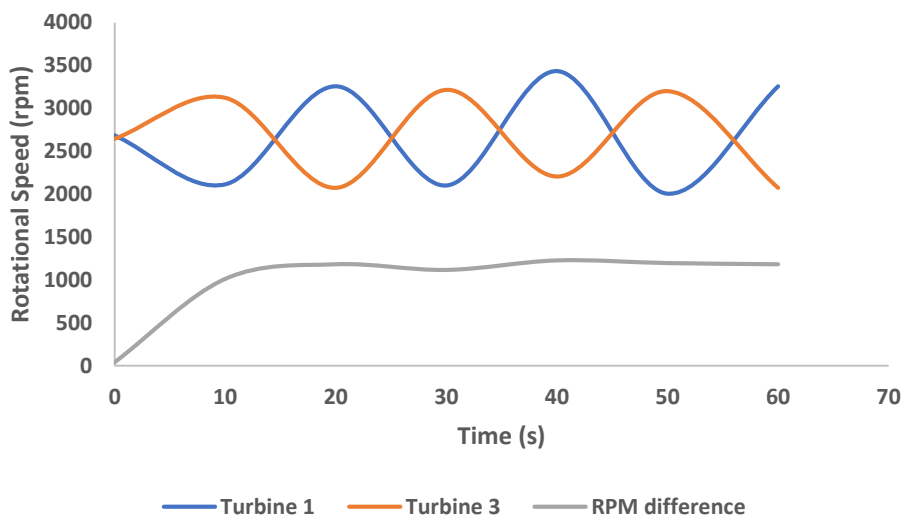

Fig. 11. Turbine Speed vs Time for turbine 1 and 3

In Figure 12, initially, both turbine 2 and turbine 4 were operating at approximately 2800 rpm, with an inlet pressure of 4 bar. However, when valve 2 received an input at $t = 10$ seconds, it caused a speed change in both turbines. Turbine 2's speed increased to around 3250 rpm, while turbine 4's speed decreased to 2323 rpm, resulting in a speed difference of approximately 930 rpm between the two turbines. Subsequently, at $t = 20$ s, valve 4 received an input, causing turbine 3's speed to increase to 3369 rpm and turbine 1's speed to decrease to 2430 rpm. This led to a speed difference of approximately 940 rpm between the two turbines. Despite these speed variations, the pressure difference between the turbines remained constant at an average of 950 rpm, indicating a stable system.

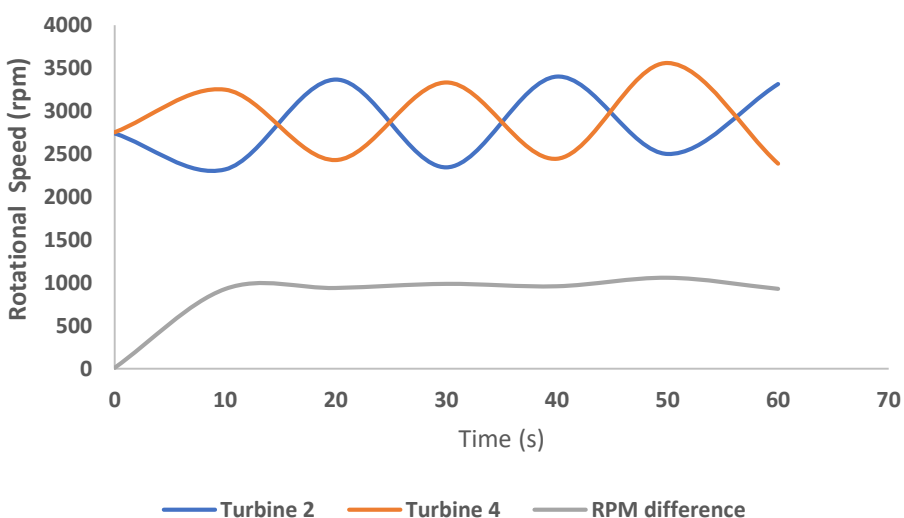

Fig. 12. Turbine Speed vs Time for turbine 2 and 4

Based on Table 3, due to slight difference of inlet air pressure from compressor 1 and compressor 2, the average minimum and maximum rpm will be different between the pair of turbines (1 and 3) and (2 and 4). For Turbine 1 and Turbine 3, the average minimum speed was around 2000 while the average maximum of rpm was around 3300. This shows that percentage of rpm difference was 11 %. While for Turbine 2 and Turbine 4, the average minimum rpm was around 2400 and for the maximum

was around 3300. The percentage difference for rpm of turbine 2 and 4 was around 9.7 %. This result shows that the turbine 1, 2, 3 and 4 shows stable system when the control valve of the inlet is implemented.

Table 3
 Percentage difference of average maximum RPM and average minimum RPM for each Turbine

Rotational Speed (rpm)	Turbine 1	Turbine 2	Turbine 3	Turbine 4
Average minimum	2072.67	2391	2118	2421
Average maximum	3314	3363.33	3179.33	3381.67
Percentage difference (%)	12.41	9.72	10.61	9.61

Apart from the turbine speed, the voltage produced during the testing also have been measured and recorded. Based on Figure 13, the maximum voltage produced for each turbine was around 30V and the minimum voltage been produced was around 16V. The minimum voltage produced by the turbine can be used to recharge the battery if the battery will be used during flying. Apart from that, it is enough to power each solenoid valve which required 12V. However, when the propeller was added on the turbine, more inlet pressure was needed to get the same voltage production as the torque needed to move the propeller was higher.

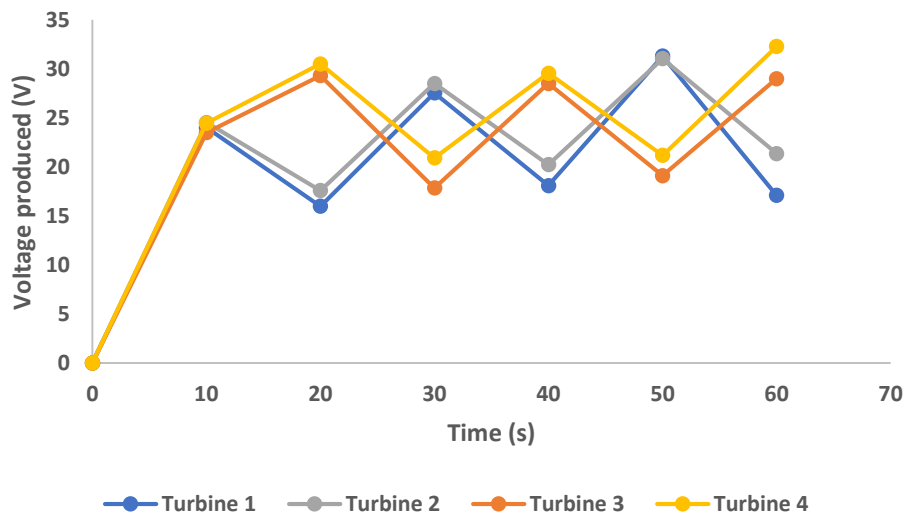

Fig. 13. Voltage production vs time

In summary, the voltage produced during turbine testing ranged from approximately 16V to approximately 30V. The minimal voltage is sufficient for battery charge and solenoid valve operation. When a propeller is added, the turbine's input pressure must be adjusted to maintain the same voltage output due to increasing torque needs. The addition of a propeller increases torque requirements and necessitates higher inlet pressure to maintain the desired voltage output. Furthermore, the rotational speed of the turbine has a direct influence on voltage production, emphasising the need of achieving the proper balance for best performance.

4. Conclusions

This paper focused on reaching the objective to use control valves concept to control the rotational speed of the turbine to make the drone have the rotational motion. The turbine and the control valves system itself have been tested to see the effectiveness on the quadcopter. All the objectives of this project were achieved. A new concept drone has been made which using the turbine for controlling the motion of the drone. The turbine can generate energy and power during flying which can then be used to recharge the battery. If this type of tethered drone be made in the future, this kind of control system using the valves can be used because based on this project, the control valves system can control the speed of each turbine, hence controlling the speed of each propeller which then is the basic principle for the drone to do pitching, rolling and yawing motion. By maximising the effectiveness of the recharging process, this optimisation adds to the sustainability of the drone's duration. By efficiently converting turbine energy into electrical power, the drone's battery may be recharged more effectively, potentially expanding flying time and decreasing charging time.

The microturbine's performance was assessed through speed and voltage output measurements, showing increased inlet pressure led to higher speeds and voltage production. The control valve system was tested, demonstrating effective control of turbine rpm for drone operation. The control valve system was tested on a quadcopter, demonstrating stable performance and achieving research objectives, confirming the control valve system's viability. Future works may focus on the whole drone rotational motion which are the rolling, yawing and pitching motion. Using the same control valves system, the movement of the quadcopter was analysed to test its manoeuvrability and the stability of the drone.

Acknowledgement

The authors would like to thank the Department of Aerospace Engineering, Universiti Putra Malaysia and the Aerospace Malaysia Research Center, Universiti Putra. This research was not funded by any grant

References

- [1] Chen, Yukai, Donkyu Baek, Alberto Bocca, Alberto Macii, Enrico Macii, and Massimo Poncino. "A case for a battery-aware model of drone energy consumption." In *2018 IEEE international telecommunications energy conference (INTELEC)*, pp. 1-8. IEEE, 2018.
- [2] P. Karanja, "How Long Does A Drone Battery Last?," DroneSourced, 2022. <https://dronesourced.com/guides/how-long-does-a-drone-battery-last/> (accessed Jan. 29, 2023).
- [3] Thu, Kyaw Myat, and A. I. Gavrilov. "Designing and modeling of quadcopter control system using L1 adaptive control." *Procedia Computer Science* 103 (2017): 528-535.
- [4] Barve, Jayesh, and Keyur Patel. "Modelling, Simulation and Altitude-Range-Analysis of Quad-Copter UAV." *IFAC Proceedings Volumes* 47, no. 1 (2014): 1126–30. <https://doi.org/10.3182/20140313-3-in-3024.00209>
- [5] Tripathy, S. C. "Digital speed governor for steam turbine." *Energy conversion and management* 35, no. 2 (1994): 159-169. [https://doi.org/10.1016/0196-8904\(94\)90076-0](https://doi.org/10.1016/0196-8904(94)90076-0)
- [6] Shao, Xuan, Yuqi Fan, Junpeng Shao, and Guitao Sun. "Improved Active Disturbance Rejection Control with the Optimization Algorithm for the Leg Joint Control of a Hydraulic Quadruped Robot." *Measurement and Control* 56, no. 7–8 (2023): 1359–76. <https://doi.org/10.1177/00202940221100298>
- [7] Mauricio Rhenals, Armando Robledo, Jonathan Fábregas, and Javier Carpintero. "Analysis of Fluid Pressure Drop through a Globe Valve Using Computational Fluid Dynamics and Statistical Techniques." *Journal of Advanced Research in Fluid Mechanics and Thermal Sciences* 115, no. 2 (2024): 70–82. <https://doi.org/10.37934/arfmts.115.2.7082>
- [8] Hui, Liu, Gu Hongbin, and Chen Dawei. "Application of High-Speed Solenoid Valve to the Semi-Active Control of Landing Gear." *Chinese Journal of Aeronautics* 21, no. 3 (2008): 232–40. [https://doi.org/10.1016/s1000-9361\(08\)60030-8](https://doi.org/10.1016/s1000-9361(08)60030-8)

- [9] Situm, Zeljko, Tihomir Zilic, and Mario Essert. "High speed solenoid valves in pneumatic servo applications." In *2007 Mediterranean Conference on Control & Automation*, pp. 1-6. IEEE, 2007. <https://doi.org/10.1109/med.2007.4433746>
- [10] Zhao, Jianhui, Meiling Wang, Zhangjun Wang, Lenoid Grekhov, Tao Qiu, and Xiuzhen Ma. "Different Boost Voltage Effects on the Dynamic Response and Energy Losses of High-Speed Solenoid Valves." *Applied Thermal Engineering* 123 (2017): 1494–1503. <https://doi.org/10.1016/j.applthermaleng.2017.05.117>
- [11] Chmielniak, T., W. Kosman, and G. Kosman. "Simulation Modules of Thermal Processes for Performance Control of CHP Plant with a Gas Turbine Unit." *Applied Thermal Engineering* 27, no. 13 (2007): 2181–87. <https://doi.org/10.1016/j.applthermaleng.2005.07.021>
- [12] Liu, Yudong, Qingjun Yang, Shangru Yang, and Zhenyang Zhang. "Improvement of Dynamic Response and Energy Conversion Ratio of a Global Type Solenoid for High-Speed Valve by Using an Innovative Magnet Ring." *Journal of Magnetism and Magnetic Materials* 598 (2024): 172061. <https://doi.org/10.1016/j.jmmm.2024.172061>
- [13] Varseveld, R.B. van, and G.M. Bone. "Accurate Position Control of a Pneumatic Actuator Using on/off Solenoid Valves." *IEEE/ASME Transactions on Mechatronics* 2, no. 3 (1997): 195–204. <https://doi.org/10.1109/3516.622972>
- [14] Taghizadeh, M., A. Ghaffari, and F. Najafi. "Modeling and Identification of a Solenoid Valve for PWM Control Applications." *Comptes Rendus. Mécanique* 337, no. 3 (2009): 131–40. <https://doi.org/10.1016/j.crme.2009.03.009>
- [15] Bijarchi, Mohamad Ali, Amirhossein Favakeh, Saeed Alborzi, and Mohammad Behshad Shafii. "Experimental Investigation of On-Demand Ferrofluid Droplet Generation in Microfluidics Using a Pulse-Width Modulation Magnetic Field with Proposed Correlation." *Sensors and Actuators B: Chemical* 329 (2021): 129274. <https://doi.org/10.1016/j.snb.2020.129274>
- [17] Yuan, Xianju, Sixiu Shi, Chuyan Wang, Lifeng Wei, Chen Luo, and Junjie Chen. "Dynamic Modeling Method for an Electro-Hydraulic Proportional Valve Coupled Mechanical–Electrical–Electromagnetic–Fluid Subsystems." *Journal of Magnetism and Magnetic Materials* 587 (2023): 171312. <https://doi.org/10.1016/j.jmmm.2023.171312>
- [18] Guo, Y., and Z. Ling. "A Magnetic Suspension Spindle System for Micro EDM." *Procedia CIRP* 42 (2016): 543–46. <https://doi.org/10.1016/j.procir.2016.02.248>
- [19] Bijanzad, A., A. Hassan, and I. Lazoglu. "Analysis of Solenoid Based Linear Compressor for Household Refrigerator." *International Journal of Refrigeration* 74 (2017): 116–28. <https://doi.org/10.1016/j.ijrefrig.2016.10.015>
- [20] Wongsathon Boonyopas, Nuttamas Uppatam, Chattawat Aroonrujiphan, Natthaporn Kaewchoothong, Somchai Sae-ung, and Chayut Nuntadusit. "Effect of Pulsating Flame Jet on Flow and Heat Transfer Characteristics." *Journal of Advanced Research in Fluid Mechanics and Thermal Sciences* 77, no. 1 (2024): 11–23.
- [21] Wang, Qilei, Fengyu Yang, Qian Yang, Junhui Chen, and Hongyan Guan. "Experimental Analysis of New High-Speed Powerful Digital Solenoid Valves." *Energy Conversion and Management* 52, no. 5 (2011): 2309–13. <https://doi.org/10.1016/j.enconman.2010.12.032>